

eMag 50 HD

Instructions for use
for the electronic magnifier

EN

eMag 50 HD

Handheld video magnifier

Instructions for use

Congratulations on purchasing the eMag 50 HD. This handheld video magnifier enables you to magnify texts and objects from 2 to 14 times the original size. The eMag 50 HD features a 5" (12.7 cm) LCD widescreen (16:9). We hope you enjoy using this high-quality device. The information and data contained in this document are subject to change without notice. No part of this document may be reproduced or transmitted in any form or by any means, electronic or mechanical, or for any purpose, without the express written approval of A. SCHWEIZER GmbH.

Distributor

A. SCHWEIZER GmbH
Hans-Böckler-Straße 7
91301 Forchheim, Germany
www.schweizer-optik.de

Service and support

If you require technical support with your eMag 50 HD, please contact the dealer who sold you the visual aid. It is recommended you first refer to "Troubleshooting" (on page 28).

Note: The eMag 50 HD contains no user serviceable components. Any unauthorised attempt to service or replace internal components will render the warranty null and void.

Table of contents

eMag 50 HD – overview	4	Switching off LED lights	20
Intended use, Clinical Use, Intended Users,		Using reading line or reading mask	21
Intended Usage Environment	4	Displaying the reading line	21
Performance Characteristics	5	Displaying the reading mask	22
eMag 50 HD Components	6	Storage mode	23
Quick start	8	Storage mode icons	23
Charging the eMag 50 HD	10	Viewing saved images	24
Battery status LED	11	Saving and deleting an image	24
Description of buttons	12	Deleting an image in Storage mode	25
Opening and closing the handle	13	Saving and deleting an image	
Opening the reading stand	14	when memory is full	25
Functions	15	Transferring images to a computer	
Magnifying live images	15	via USB cable	26
Magnifying captured and		Transferring images to the eMag 50 HD	
saved images	15	via USB cable	27
Changing colour modes	16	Troubleshooting	28
Changing between the last colour mode		Technical data	30
used and true full colour	16	Safety and maintenance	31
Adding/removing colour modes	17	Cleaning the eMag 50 HD housing	32
Restoring default colour modes	18	Cleaning the eMag 50 HD LCD screen	32
Colour modes	18	Battery safety instructions	33
Default colour modes	18	Symbol guide	34
Optional colour modes	19		
Capturing an image	20		

eMag 50 HD – overview

Intended use

This electrical device serves to electronically enlarge objects or for reading printed materials in everyday use.

Clinical Use

This electrical device contributes significantly to daily tasks, facilitates independence, increases productivity and improves self-esteem.

Intended Users

This device is for people with visual impairments or for others who would like to view text, pictures or objects enlarged.

Intended Usage Environment

This device is intended for use at home, at the office and out and about. It is for enlarging and improving pictures and texts for users.

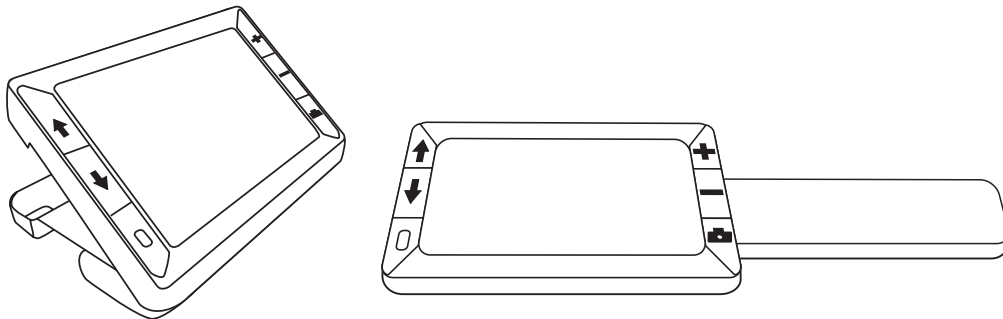

Performance Characteristics

Make sure the batteries are fully charged before using the eMag 50 HD for the first time. It takes about 3.5 hours to fully charge the batteries.

The eMag 50 HD is a portable, handheld video magnifier that can magnify an object from **2 to 14 times its original size**. The integrated 5 MP auto-focus camera provides sharp **HD quality** images that are easily viewed on its full-colour, **5" LCD screen**. The eMag 50 HD supports 5 default colour modes and 15 additional **contrast colour modes** that can be easily activated.

The eMag 50 HD has both an integrated **folding handle and a reading stand**. The handle allows you to hold the magnifier close to an object, press the magnification button for continuous zoom from 2 to 14 times the original size and then capture the image on the screen. If you want, you can then adjust the **magnification** as required. This is ideal for reading clothing labels, prescriptions, price tags, receipts, business cards etc.

With the **reading stand opened**, you can place the eMag 50 HD directly on a document and read printed text or images in magazines, catalogues, menus, photos or other printed matter.

The eMag 50 HD can save and store up to **80 images**, which can be copied to a computer via a simple USB connection.

In addition, the eMag 50 HD has a **reading line and reading mask** feature that you can turn on and use to quickly locate and maintain your place while viewing an image or reading text on the LCD screen.

eMag 50 HD Components

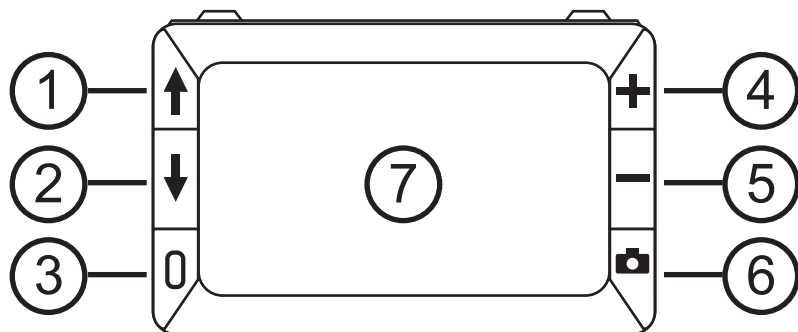

- 1 Colour mode scroll up (blue)
- 2 Colour mode scroll down (blue)
- 3 Power on/off (green/yellow)
- 4 Increase magnification (yellow)
- 5 Decrease magnification (yellow)
- 6 Capture image (red)
- 7 LCD screen

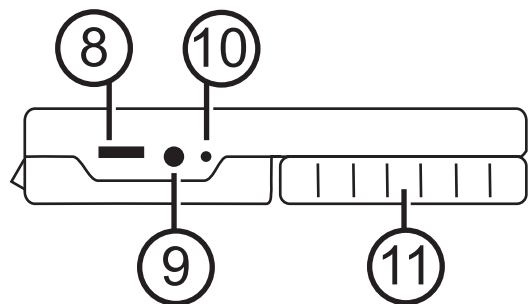

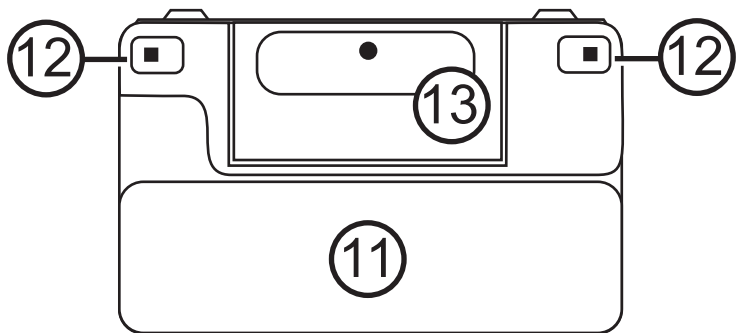

- 8 USB port (micro USB)
- 9 Power adapter port (5V; 2.4A)
- 10 Battery status LED
- 11 Handle in closed position



- 11 Handle in closed position
- 12 LED lights
- 13 Camera (5 MP)

Quick start

This section explains how to quickly set up the eMag 50 HD and use it for the first time.

1. Make sure that the **device is fully charged** (Refer to pages 10/11).
2. **Switch on the eMag 50 HD** by pressing the green/yellow button  (Refer to page 12).
3. Select one of the following options:
 - Turn and extend the **handle** to hold and use the eMag 50 HD like a magnifying glass. This is useful if you need to magnify and read labels or small print on tins, packaging, medication etc. (Refer to page 13).
 - Open the **reading stand** and place the eMag 50 HD on a flat document, such as a newspaper or magazine, an invoice or a receipt, a letter etc (Refer to page 14).
4. Adjust the level of **magnification** with the yellow buttons (**+** or **-**) (Refer to page 15).
5. Select a **colour mode** (**↑** or **↓**) for **contrasting colours** that best suit your viewing needs (Refer to page 16/17).
6. **Capture the image** on the LCD screen  so that you can take the time you need to see the details in the image (Refer to page 20).
7. **Save the image** or return to **live view**  (Refer to page 24).

As soon as you feel comfortable with the basic functions of the eMag 50 HD, try out the following **advanced functions**:

- Turn the **LED reading lights on and off** to avoid glare and reflections when looking at photos or glossy magazines (Refer to page 10).
- Use the **reading line or reading mask** to help you maintain your place in the text you are reading (Refer to pagea 21 / 22).
- You can **save and view images** and also **delete images** saved on the eMag 50 HD (Refer to pages 26 / 25).
- For additional memory space, **copy the images from the eMag 50 HD to your computer** (Refer to page 26).

Charging the eMag 50 HD

Note: You must use the supplied power adapter to charge the eMag 50 HD. It cannot be charged via the USB port on a computer.

1. Plug one end of the power adapter into the eMag 50 HD and the other end into the wall outlet (1).

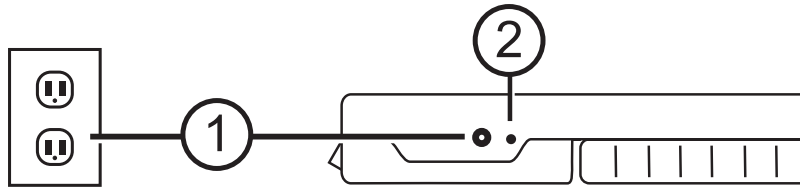

2. The battery status LED flashes green to show that the battery is charging (2).
3. As soon as the battery is fully charged, the LED stops flashing and remains green.
Unplug the eMag 50 HD power adapter. The battery status LED turns off. You can now use the eMag 50 HD continuously for approximately 3 hours. When the battery is running low, the battery status LED flashes red. Connect the power adapter and plug it in to recharge the battery.

Note: The eMag 50 HD switches to power save mode after 30 minutes (screen switches off) if no button is pressed during this time. Press the green/yellow power button  to reactivate the eMag 50 HD.

Battery status LED

Green solid: Batteries are charged, power adapter connected.

Green flashing: Batteries are charging, power adapter connected.

Red flashing: Low battery status.

Red solid: Error: disconnect power adapter, wait a few seconds and then reconnect it.

Description of buttons

On/Off (green/yellow):  Press once to switch on, press again to switch off.

Magnification (yellow):  Press and HOLD for continuous zoom magnification with live view. When viewing captured images, press and release to incrementally increase or decrease magnification.

Colour mode (blue):  Press to scroll through the default colour modes and 15 additional colour combinations.
For a complete overview go to page 18/19.

Capture image (red):  Press to capture the current image. Press the button again to turn off the "Capture image" mode and return to live view.

Opening and closing the handle

The handle can be opened in 2 positions, allowing you to hold the eMag 50 HD like a magnifying glass.

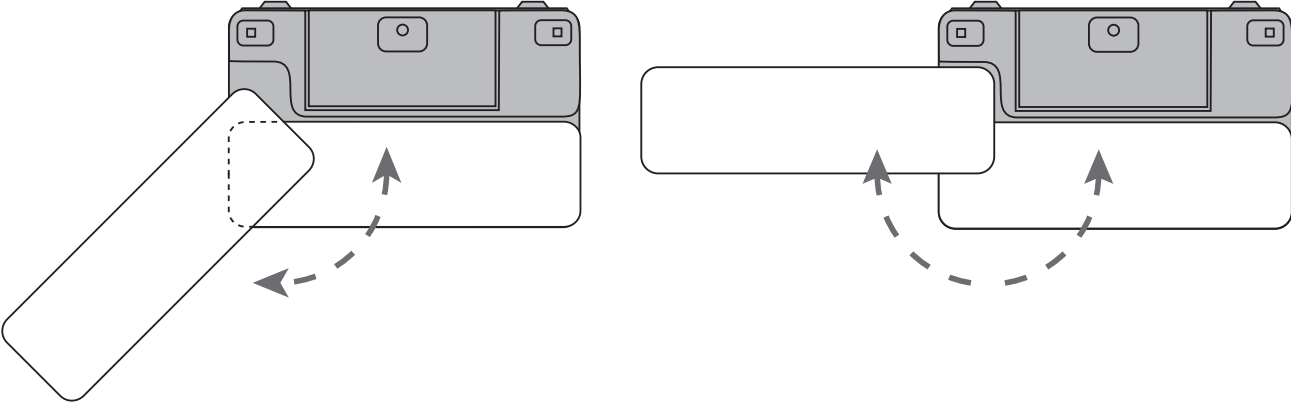

Opening the reading stand

The eMag 50 HD also has a reading stand, which – as soon as it is positioned on a document – allows you to read an item from a constant and convenient distance.

1. Slide the upper edge of the eMag 50 HD screen in one direction with one thumb while pushing one of the buttons (2a or 2b) in the opposite direction with your other thumb.

2. A spring opens the eMag 50 HD to the full reading position. If the eMag 50 HD is switched off, it is automatically switched on as soon as you open the reading stand.

3. Now place the eMag 50 HD on a flat item, for example a photo or document, to view and read it.

4. When you close the reading stand, the device automatically turns off.

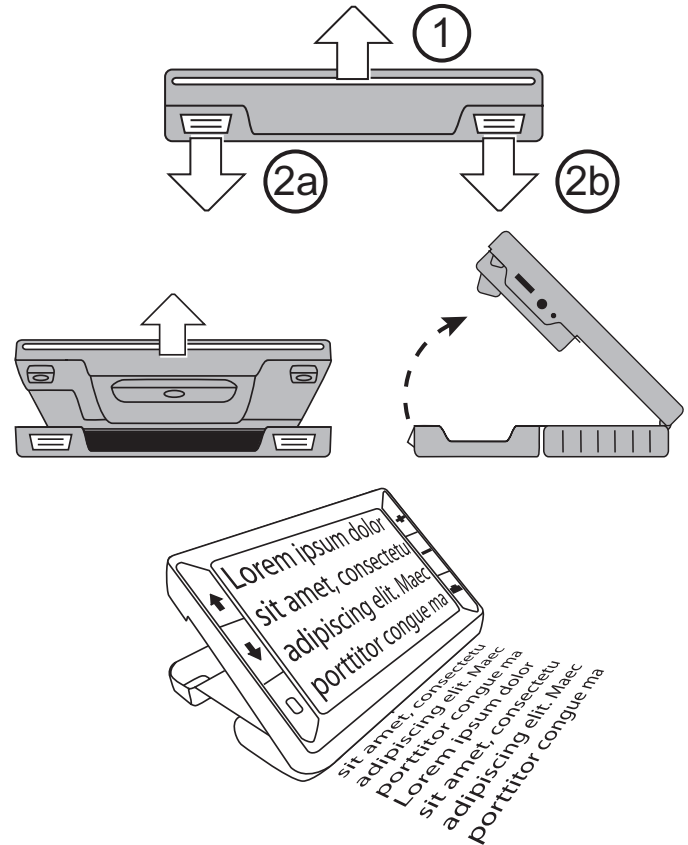

Functions

Magnifying live images

When viewing live images, you can use the continuous zoom function to magnify live images from 2x to 14x the original size.

- Press and HOLD the yellow PLUS button **+** to zoom in.
- Press and HOLD the yellow MINUS button **-** to zoom out.

Magnifying captured and saved images

You can capture an image on the LCD display and save it. When viewing captured or saved images, you can zoom in and out in incremental steps by pressing the yellow buttons (**+** or **-**).

For steps to capture an image, refer to **Capturing an image** on page 20.

To access saved images, see **Saving and deleting an image** on page 24.

Changing colour modes

Colour modes are preset colour combinations (for example, yellow text on a blue background) that you can individually select when using the eMag 50 HD.

The eMag 50 HD offers 5 default colour modes and 15 additional colour combinations. For a complete list, refer to **Colour modes** on page 18/19.

Press the blue arrow buttons (↑ or ↓) to change the current colour combination on the LCD screen. The blue UP arrow ↑ scrolls in one direction through the colour combination list, while the blue down arrow ↓ scrolls in the other direction.

Changing between the last colour mode used and true full colour









The eMag 50 HD allows you to switch quickly and comfortably between the last colour mode used and full colour – or vice versa. This shortcut is handy when viewing a live image (for example, when holding and reading a document) and using a colour mode that provides the best contrast for you. If you need to move the eMag 50 HD to a different part of the document, it may be easier for you to switch to full colour mode, move to the new position in the document and then return to the selected colour mode to continue reading. To do this, proceed as follows:

- Press and HOLD the green/yellow button  and press the blue DOWN arrow ↓.
- The monitor switches from one mode to the other.
- To switch back, repeat the same button sequence.

Adding/removing colour modes

The eMag 50 HD has 5 default colour modes. You can also activate and choose from a variety of 15 other colour modes. As soon as a colour mode is available, you can easily scroll to it using the blue arrow buttons (↑ or ↓).

To add or remove other colour modes:

1. Press and HOLD the green/yellow button  and then press the blue UP arrow  to access the colour mode selection menu.
The tick in the checkbox indicates that the current colour mode is activated.
2. To delete the current colour mode, press the blue DOWN arrow  while STILL holding the green/yellow button  pressed. This button sequence clears the checkbox .
3. To select the next colour mode, press the blue UP arrow  while STILL holding the green/yellow button  pressed.
 - If the checkbox is selected , the colour mode is activated.
 - If the checkbox is empty , the colour mode is deactivated.
4. To activate or deactivate a colour mode, press the blue DOWN arrow  while cholding the green/yellow button  to select or clear the checkbox.
5. Repeat steps 3 and 4 to add or remove further colour modes.
6. When you have finished loading colour modes, release all buttons. Any colour mode changes made will be saved and the device will return to normal operating mode.

Restoring default colour modes

If you have added or removed optional colour modes, you can always reset the eMag 50 HD to its 5 default colour modes:

Press and HOLD the green/yellow button  and the blue UP arrow  simultaneously for 15 seconds.

Colour modes

There are 5 default colour modes and 15 optional colour modes that you can activate yourself.

Default colour modes





1. True full colour (always available, cannot be deactivated)
2. Black on white
3. White on black
4. Yellow on blue
5. Yellow on black

Optional colour modes

- Black on yellow
- Green on black
- Black on green
- White on blue
- Black on blue
- Blue on black
- Blue on yellow
- Red on black
- Black on red
- Magenta on black
- Black on magenta
- Violet on black
- Black on violet
- Red on white
- Black on light blue

Capturing an image





Capturing an image on the LCD screen can be useful for reading labels on objects or supermarket shelves. By holding the eMag 50 HD close to an object and capturing the image, you can then hold the eMag 50 HD closer to you to read the information.

1. Press the red button  to capture an image.
If desired, press the yellow PLUS button  to magnify the image or the yellow MINUS button  to reduce the size of the image.
2. Press the red button  again to exit the image capturing mode and return to live view.

Note: To save a captured image, press and HOLD the red button  for 3 seconds. You will find further information under **Saving and deleting an image** on page 24.

Switching off LED lights

When you power on the eMag 50 HD, the LED lights also switch on. To avoid glare when looking at reflective surfaces, you can switch off the LED lights:

1. Press and HOLD the green/yellow button  and then press the red button .
The LED lights turn off.
2. To switch the LED lights on again, press and HOLD the green/yellow button  and then press the red button .

Using reading line or reading mask

The reading line is a horizontal line which appears on the screen. The reading mask blocks part of the screen so that only a horizontal section of the screen remains visible. Use these features to help you locate and maintain your place while viewing an image. When using the button sequence described below, the eMag 50 HD shows first the reading line, then the reading mask and then neither the reading line nor the reading mask.

Displaying the reading line

1. Press and HOLD the green/yellow button  (1) and then press both yellow buttons (**+** and **-**(2 and 3)).
The reading line appears on the screen as shown below:

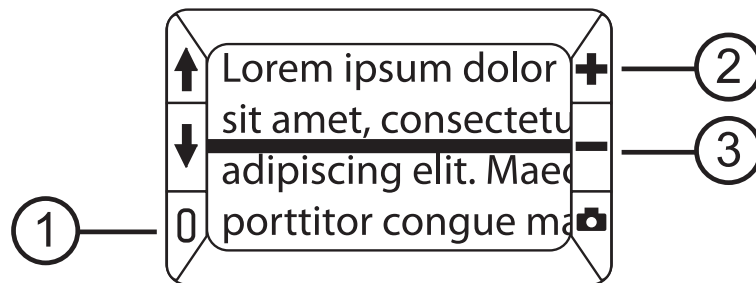



2. Press and HOLD the green/yellow button  (1) and then press the yellow PLUS button **+**(2) or the yellow MINUS button **-**(3) to move the reading line up or down.

Displaying the reading mask

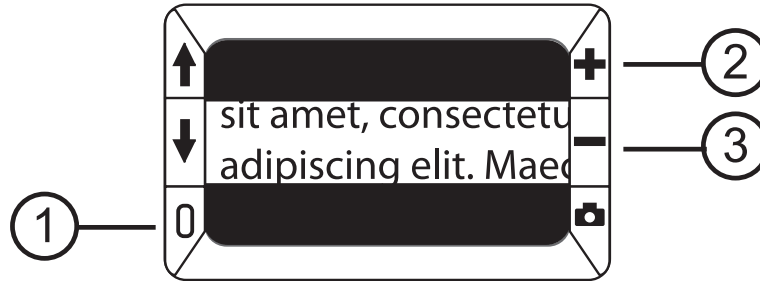
1. Press and HOLD the green / yellow button  (1) and then press both yellow buttons (**+** and **-** (2 and 3)) again to remove the reading line and display the reading mask on the screen as shown below:





2. Press and HOLD the green/yellow button  (1) and then press the yellow PLUS button **+**(2) or the yellow MINUS button **-**(3) to increase or decrease the size of the window between the bars on the screen.
3. To remove the reading mask from the screen, press and HOLD the green/yellow button  (1) and then press and HOLD both yellow buttons (**+** and **-** (2 and 3)).

Storage mode

The Storage mode allows you to store up to 80 images. When you first store an image, it is saved with the currently displayed magnification and colour settings. When **viewing a saved image**, you can change the **magnification level** (Refer to page 15).

Storage mode icons

- Save:**  Press the 2 yellow buttons (**+** and **-**) simultaneously to activate the checkbox. The image will be saved when you exit Storage mode.
- Delete:**  Press the 2 yellow buttons (**+** and **-**) simultaneously to clear the checkbox . The image will be deleted when you exit Storage mode.
- Memory full:**  Indicates that the maximum number of images has been stored on the eMag 50 HD. You will need to select one or more images for deletion before you can save the current image.

Viewing saved images

The eMag 50 HD can store up to 80 images. You can easily scroll through your saved images using the blue arrow buttons (↑ and ↓):

1. Press and HOLD the red button  for approx. 6 seconds to access Overview mode.
 - To scroll forwards through the saved images, press the blue UP arrow ↑.
 - To scroll backwards through the saved images, press the blue DOWN arrow ↓.

Note: To scroll quickly through the images, press and HOLD one of the two blue arrow buttons (↑ or ↓). Release the button to stop scrolling.

2. Press and HOLD the red button  for approx. 3 seconds to exit this view and return to live view.

Saving and deleting an image

After capturing an image on the screen, follow the steps below to **save** it:



1. Press and HOLD the red button  for 6 seconds to enter Storage mode.
2. The "Save" checkbox is automatically selected on the screen. This indicates that the image will be saved after exiting the Storage mode and returning to live view.

Deleting an image in Storage mode

1. Press and HOLD the two yellow buttons (+ and -) to clear the checkbox . The image will be deleted when you exit Storage mode.
2. Press and HOLD the red button  for 3 seconds to exit Storage mode and return to live view.

Saving and deleting an image when memory is full

The eMag 50 HD can store up to 80 images. If you try to save a further image, the Memory full icon  appears on the screen. To save a further image, you first need to delete one or more saved images from the memory.

1. Press the blue UP arrow  or the blue DOWN arrow  until you reach the image you wish to delete.
2. Press both yellow buttons (+ and -) to clear the checkbox .
3. Press and HOLD the red button  for 3 seconds to exit Storage mode. The new image is saved and all deactivated images are deleted.

Note: To free space on the eMag 50 HD, you can copy images to a computer. See also **Transferring images to a computer via USB cable** on page 26.

Transferring images to a computer via USB cable

Images stored on the eMag 50 HD can be transferred to a computer using the supplied USB cable.

1. Connect the USB cable supplied to the eMag 50 HD (1) and the computer.



2. When connected,

- the USB and battery icon briefly appear on the LCD screen.



- the battery icon indicates the current battery status. The eMag 50 HD does not charge and no image appears on the screen while it is connected to the computer via USB.
- the eMag 50 HD appears as an external device in Explorer (Windows) or Finder (Mac).

3. Open the "eMag 50 HD DCIM" folder and use the "drag and drop" method to move or copy one or more images to a folder or the desktop on your computer. The images are named and numbered in the order saved, for example IMG_0001.bmp, IMG_0002.bmp etc.
4. Once you have finished transferring the files, make sure you disconnect the eMag 50 HD correctly from the computer.

Note: To safely disconnect the eMag 50 HD and protect your data, follow the prompts from your operating system for removing external USB devices.

Transferring images to the eMag 50 HD via USB cable

Any image transferred from the eMag 50 HD to your computer can be easily transferred back to the eMag 50 HD.

Note: Only images saved by the eMag 50 HD can be copied back to the eMag 50 HD.

1. Make sure the eMag 50 HD is connected to your computer using the supplied USB cable.
2. Locate the images on your computer using Windows Explorer or Finder (Mac).
3. Select the image and drag it to the "eMag 50 HD DCIM" folder.
4. Once you have finished transferring the files, make sure you disconnect the eMag 50 HD correctly from the computer.

Note: To safely disconnect the eMag 50 HD and protect your data, follow the prompts from your operating system for removing external USB devices.

Troubleshooting

Problem	Solution
The device does not power on.	<p>Press the green/yellow power button. If the eMag 50 HD does not power on, charge or replace the battery.</p> <p>Note: The battery does not charge while the eMag 50 HD is connected to the USB port.</p>
The screen is blank.	<ul style="list-style-type: none">▪ If the eMag 50 HD is sitting on a flat surface surface (table or document), the screen is blank (black). Lift the device off the surface, or open the reading stand.▪ When the eMag 50 HD is connected to a computer via USB, the screen is blank.▪ Switch the eMag 50 HD off and then on again.▪ Check that the object to be magnified is positioned correctly under the camera window.▪ Press the yellow magnification button to run through the magnification levels.▪ Press the blue arrow buttons to view the various colour modes.▪ When the reading stand is closed, the device automatically powers off.
The battery status LED is flashing red.	Charge the battery.
The battery status LED is solid red although the power adapter is connected to the eMag 50 HD.	<ul style="list-style-type: none">▪ A battery error has occurred. Unplug the power adapter from the eMag 50 HD and plug it in again.▪ If the problem continues, disconnect the power adapter and call your eMag 50 HD dealer.

Problem	Solution
The battery status LED does not flash green, although the power adapter is connected and plugged into a wall socket.	<ul style="list-style-type: none"> ▪ Check that the barrel end of the power adapter is firmly plugged into the device's power port. ▪ Check whether the power outlet is functioning properly.
The battery is not charging.	<ul style="list-style-type: none"> ▪ Use the supplied power adapter to charge the eMag 50 HD. The battery does not charge when the eMag 50 HD is connected to a USB port. ▪ Make sure the barrel end of the power adapter is firmly plugged into the device's power port. ▪ Check whether the power outlet is functioning properly.
The screen is dirty or smudged.	Clean the LCD screen as described on page 32.
The text is too small or too large to read.	Press the yellow magnification buttons to increase or decrease magnification. For live images, press and HOLD the magnification button for continuous zoom magnification. For captured or saved images, press the magnification buttons to zoom in or out one step at a time.
LED lights produce glare on reflective surfaces.	Press and HOLD the green/yellow power button and then press the red button (Capture image) to turn the LED lights off.
The eMag 50 HD powers off after 30 minutes.	This is expected behaviour. The eMag 50 HD powers off automatically if no buttons are pressed for 30 minutes. This extends battery life.

Technical data

LCD display:	5 inches (127 mm) widescreen; tilts approx. 40° in reading mode
Dimensions:	139.7 mm (width) x 88.9 mm (depth) x 20.3 mm (height)
Weight:	298 g
Colour modes:	5 default colour modes (full colour, white on black, black on white, yellow on blue, yellow on black) and 15 additional colour modes
Magnification:	2 x to 14 x, continuous zoom
Maximum number of saved images:	Up to 80 bitmap (BMP) images
Camera:	5 MP HD auto-focus camera module
Battery:	Lithium-ion battery, approx. 3 hours continuous operation, approx. 3.5 hours charge time

Note: Only use the supplied power adapter to charge the eMag 50 HD battery.

Manufacturer

Vispero
Pesetastraat 5a
2991 XT Barendrecht
Nederland



Class 1 LED Product



RoHS



Safety and maintenance

- Do not attempt to repair the eMag 50 HD yourself or open the housing. This product contains no user serviceable parts. Any unauthorised attempt to service or replace internal components will render the warranty null and void.
- Do not remove the battery. It is not user serviceable.
- Keep the eMag 50 HD away from wet areas, rain and other sources of moisture.
Do not immerse the eMag 50 HD in water.
- Always operate the eMag 50 HD at an ambient temperature between 10° and 35° C.
- Never store the eMag 50 HD in places subject to temperature extremes such as a parked car.
- Do not force any connector into the power port of the eMag 50 HD. The power connector fits easily into the port.

Cleaning the eMag 50 HD housing

Make sure the eMag 50 HD is unplugged. Use a slightly dampened, soft, clean cloth with water or a mild detergent. Do not use alcohol, solvents, abrasives or aerosol sprays.

Cleaning the eMag 50 HD LCD screen

- Power off and unplug the eMag 50 HD before cleaning the LCD screen.
- Always use a clean microfibre cloth.
- Very gently wipe the cloth across the screen. Do not exert pressure on the cloth or the LCD screen.
- If you use a liquid detergent, it must be suitable for use on LCD screens. You can also use distilled water, isopropyl alcohol or vinegar mixed with water at a concentration of no more than 10 percent vinegar. Please note that tap or mineral water may cause spotting on the screen. Do not leave any liquid on the screen. Repeat this procedure for any marks that are hard to remove.
- NEVER spray detergent directly on the LCD screen.
- NEVER use a cleanser that contains acetone, ethyl alcohol, ethyl acid, ammonia or methyl chloride.
- NEVER use paper towels to clean the LCD screen.

Battery safety instructions







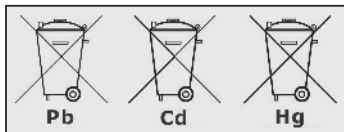









We place our batteries on the market in line with legal requirements. Please read the points below for the safe removal and disposal of our batteries:

- Our product contains a rechargeable battery.
- To prevent harmful effects to the environment and health, used batteries must be disposed of properly at recycling centres or returned to the point of sale. Returning batteries is required by law and free of charge for you.
- Batteries should only be returned in a fully discharged state. The poles of lithium-ion batteries must be insulated with adhesive tape.
- Valuable raw materials such as zinc, iron, nickel and so on can be recovered by recycling used batteries.
- The “crossed out wheeled bin” symbol indicates that disposal of used batteries along with normal refuse is illegal.

The additional specification of the chemical symbols for lead (Pb), cadmium (Cd) and mercury (Hg) indicates that these materials are contained in the batteries in legally permissible quantities.



Symbol guide

	Item no
	Batch number
	Serial number
	Medical device
	Authorised representative
	Manufacture
	Manufacture date
	Barcode
	Fragile, handle with care
	Protect from moisture
	Warning
	Consult instructions for use
	Disposal information
	Power supply
	Declaration of conformity
	CE marking of conformity

A. SCHWEIZER GmbH
Hans-Böckler-Straße 7, 91301 Forchheim, Germany
Phone +49 9191-72100, Fax +49 9191-721072
info@schweizer-optik.de, www.schweizer-optik.de

23-046 / 350108-EN / 06